

SH260 Series • Inductors for National's 260kHz Simple Switcher™

Compatible with National Semiconductor's Simple Switcher™
 Part Numbers LM267X-L41 and LM267X-L45 through LM267X-L50

Features

- High energy storage with minimum saturation
- High stability from no load to full load
- Available in both SMD and THT versions
- Manufactured in ISO 9001:2015 and ISO 14001:2015 certified Talema facility
- Meets lead free reflow level J-STD-020F for SMD
- Fully RoHS & REACH Compliant



Electrical Specifications @25°C

Test frequency: Inductance measured @20KHz / 10mV

Test voltage between windings: 500Vrms

Operating temperature range: -40°C to +125°C

Climatic Category: IEC68-1 40/125/56



Part Number	National Part Number	Rated Current (I _{DC})	Inductance (μH) ±20%	ET _{OP} (V-μSec) Max. @ 260kHz	DCR Nominal (mOhm)	Package Size	
						Package Code	Lead Dia. (mm)
SH260C-4.9-23	LM267X-L41	4.9	22.8	23.3	36	C3	0.80
SH260C-4.3-10	LM267X-L45	4.3	10.2	10.0	26	C1	0.75
SH260C-5.0-15	LM267X-L46	5.0	14.8	17.0	23	C2	0.80
SH260C-5.0-10	LM267X-L47	5.0	10	13.0	25	C2	0.75
SH260C-5.0-50	LM267X-L48	5.0	50	40.0	50	C4	0.90
SH260C-5.0-33	LM267X-L49	5.0	33	36.0	47	C4	0.80
SH260C-5.0-23	LM267X-L50	5.0	23	24.0	26	C3	0.80
SH260S-4.9-23	LM267X-L41	4.9	22.8	23.3	36	SH6A	-
SH260S-4.3-10	LM267X-L45	4.3	10	10.0	26	S4	-
SH260S-5.0-15	LM267X-L46	5.0	15	17.0	27	S5	-
SH260S-5.0-10	LM267X-L47	5.0	11	13.0	25	S5	-
SH260S-5.0-50	LM267X-L48	5.0	52*	40.0	25	SHC7	-
SH260S-5.0-33	LM267X-L49	5.0	36*	36.0	19	SHC7	-
SH260S-5.0-23	LM267X-L50	5.0	24.7*	24.0	13	SHC7	-
SH260T-4.9-23	LM267X-L41	4.9	22.8	23.3	36	TH6A	-
SH260T-4.3-10	LM267X-L45	4.3	10	10.0	26	T4	-
SH260T-5.0-15	LM267X-L46	5.0	15	17.0	27	F2	-
SH260T-5.0-10	LM267X-L47	5.0	11	13.0	25	F2	-

* Note: Series connection with pins 2 - 4 connected

Type SH260C - Clip Mount

Part Number	Size Code	Dimensions - Inches ±0.01 (mm ±0.25)				
		C	D	E	Coil OD	X = Coil OD +
SH260C-4.3-10	C1	0.580 (14.73)	0.340 (8.64)	0.220 (5.58)	0.605 (15.40)	0.110 (2.80)
SH260C-5.0-15	C2	0.650 (16.50)	0.449 (11.40)	0.299 (7.60)	0.640 (16.26)	0.110 (2.80)
SH260C-5.0-10	C2	0.650 (16.50)	0.449 (11.40)	0.299 (7.60)	0.590 (15.00)	0.110 (2.80)
SH260C-4.9-23	C3	0.827 (21.00)	0.449 (11.40)	0.299 (7.60)	0.840 (21.34)	0.110 (2.80)
SH260C-5.0-50	C4	0.949 (24.10)	0.598 (15.20)	0.449 (11.40)	1.240 (31.50)	0.110 (2.80)
SH260C-5.0-33	C4	0.949 (24.10)	0.598 (15.20)	0.449 (11.40)	1.240 (31.50)	0.110 (2.80)

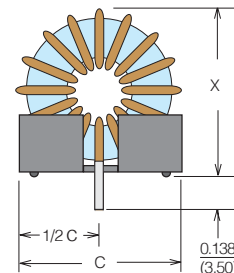

Schematic

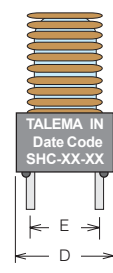
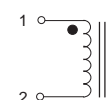

Suggested Pad Layout

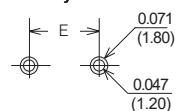

Mounting Styles • SH260 Series • Low Cost Toroidal Inductors

Type S4, S5, SH6A - Surface Mount

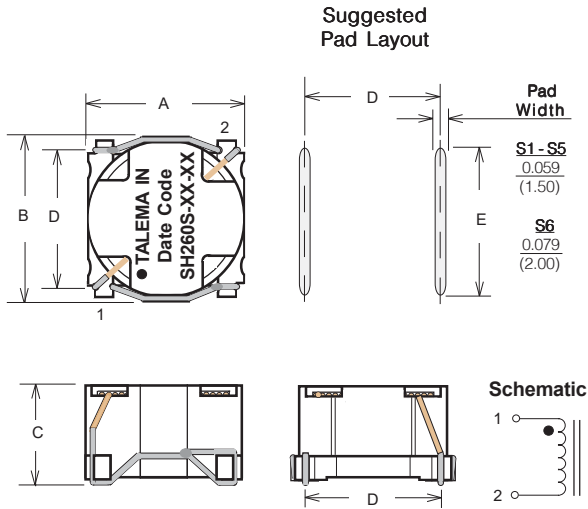

Surface Coplanarity will be <math><0.005(0.13)</math>

Type SHC7 - Surface Mount

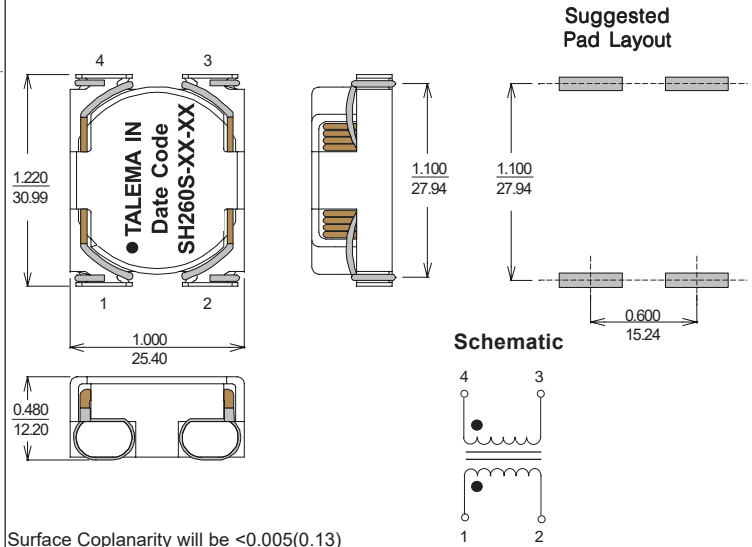

Surface Coplanarity will be <math><0.005(0.13)</math>

Type T4 & TH6A - Through Hole Mount

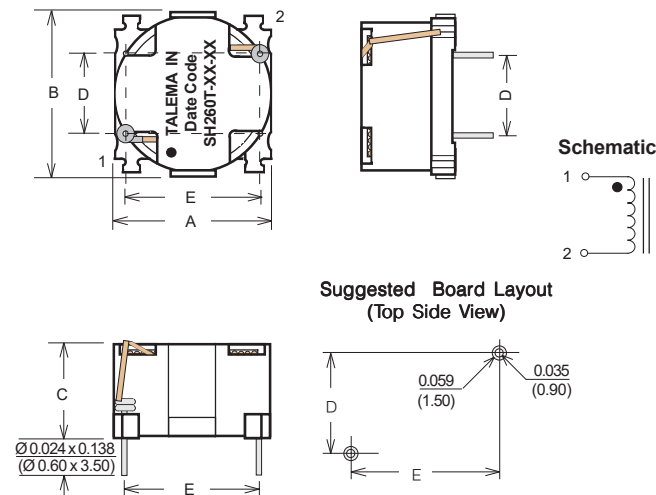

Type SH260F - Flat Mount - Size F2

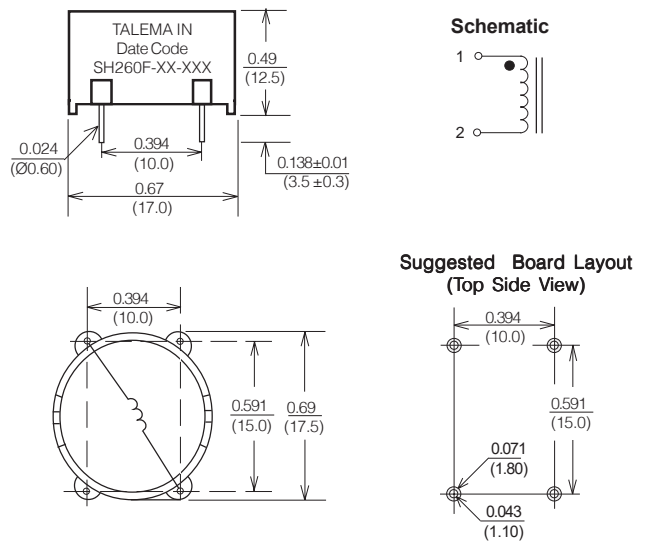

Mounting Style	Size Code	Dimensions - Inches ± 0.010 (mm ± 0.25)				
		A	B	C	D	E
"S" SMD	S4	0.591 (15.0)	0.614 (15.6)	0.394 (10.0)	0.508 (12.9)	0.551 (14.0)
	S5	0.669 (17.0)	0.701 (17.8)	0.441 (11.2)	0.591 (15.0)	0.630 (16.0)
	SH6A	0.925 (23.5)	0.957 (24.3)	0.417 (10.6)	0.827 (21.0)	0.748 (19.0)
"T" THT	T4	0.591 (15.0)	0.614 (15.6)	0.358 (9.10)	0.300 (7.62)	0.500 (12.70)
	TH6A	0.925 (23.5)	0.957 (24.3)	0.386 (9.80)	0.650 (16.51)	0.800 (20.32)

Talema Group Regional Offices

North America

**United States
(Sales & Marketing)**

Talema Group, LLC
 PO Box 935
 900 Innovation Drive
 Suite 120, Rolla
 Missouri 65402
 Tel: +1 573-303-3675
 E-Mail:
 sales@talemagroup.com
 Web: www.talema.com

Asia

**India
(Design, Manufacturing, Sales & Marketing)**

Administrative Office
Talema Electronic India Private Limited
 Door No. 221, 1st and 2nd Floor
 KJ Plaza, Opp.to Vidya Mandir School
 Meyanoor Main Road
 Salem - 636 004 Tamil Nadu INDIA
 Tel: +91 427 - 243 3100
 Fax: +91 427 - 243 3109
 E-Mail: talema@talemaindia.net
 Web: www.talema.com

Factory Premises
Talema Electronic India Private Limited
 Plot Nos. 30, 31 Electrical and Electronic
 Industrial Estate
 Suramangalam
 Salem - 636 005 Tamil Nadu INDIA
 Tel: +91 427 - 243 3000
 E-Mail: talema@talemaindia.net
 Web: www.talema.com

Europe

**Germany
(Design, Sales & Marketing)**

Talema Elektronik GmbH
 Sembdnerstr. 5
 82110 Germering
 Tel: +49 89 - 841 00 - 0
 Fax: +49 89 - 841 00 25
 E-Mail: info@talema.de
 Web: www.talema.com

**Ireland
(Design, Sales & Marketing)**

Nuvotem TEO
 Units W & X, Gweedore Business Park
 Derrybeg, Letterkenny, Co. Donegal
 Tel: +353 (0) 74 95 48666
 Fax: +353 (0) 74 95 48139
 E-Mail: info@nuvotem.com
 Web: www.nuvotem.com

**Czech Republic
(Design, Manufacturing, Sales & Marketing)**

NT Magnetics s.r.o.
 Chebská 27
 322 00 Plzeň
 Tel: +420 377 - 338 351
 Fax: +420 377 - 338 350
 E-Mail: talema@talema.cz
 Web: www.ntmagnetics.cz

Locations of Talema Group Regional Offices

